

Features

- 12" heavy duty paper cone
- Built-in mass plug with threaded hole allows easy mass addition
- Full suspension system provides stable operation
- Rubber surround

Parameters

Impedance (Ω)	
Re (Ω)	
Le (mH) @ 1 kHz	
Fs (Hz)	16.8
Qms	3.00
Qes	
Qts	
Mms (g)	200
Cms (mm/N)	0.45
Sd (cm ²)	480.0
Vd (liters)	480.0
BL (Tm)	
VAS (liters)	5.2
XMAX (mm)	10
VC Diameter (mm)	
SPL (dB@1W/1m)	
RMS Power Handling (W)	
Usable Frequency Range (Hz)	

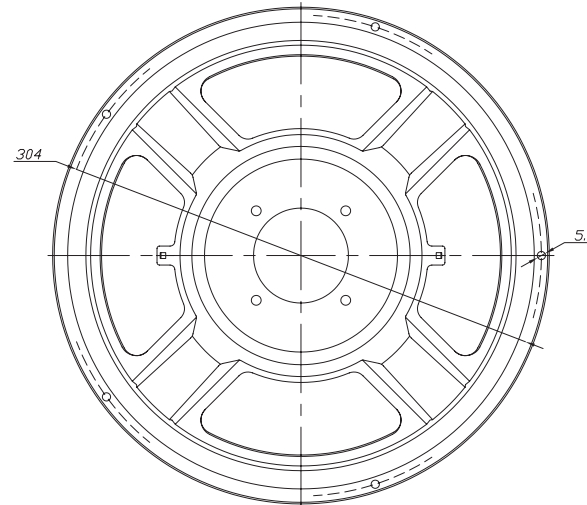
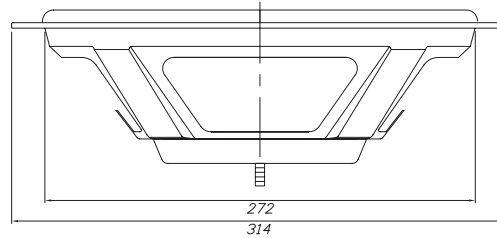

Note: All dimensions in mm.

Frequency Response

N/A

Note: Due to testing limitations, response below 200 Hz is not an actual representation.

Impedance/Phase

N/A