

Features

- Lightweight black anodized aluminum cone
- 4 ohm nominal impedance
- Attractive 6-hole cast frame
- Advanced low distortion motor design
- Solid aluminum phase plug
- Rubber surround

Parameters

Impedance (Ω)	4
Re (Ω)	2.9
Le (mH) @ 1 kHz	0.56
Fs (Hz)	37.7
Qms	2.39
Qes	0.56
Qts	0.46
Mms (g)	32.02
Cms (mm/N)	0.56
Sd (cm ²)	219.0
Vd (liters)	131.4
BL (Tm)	6.47
VAS (liters)	37.5
XMAX (mm)	6
VC Diameter (mm)	38
SPL (dB@1W/1m)	89.0
RMS Power Handling (w)	80
Usable Frequency Range (Hz)	40 - 2000

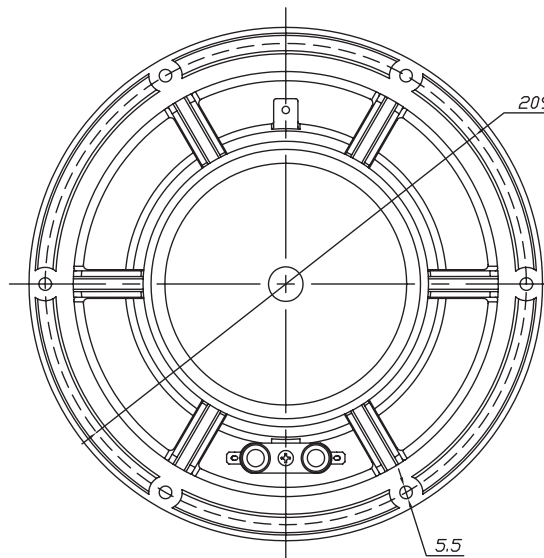
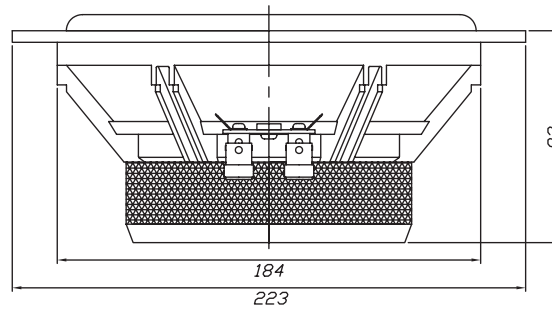

Note: All dimensions in mm.

Frequency Response

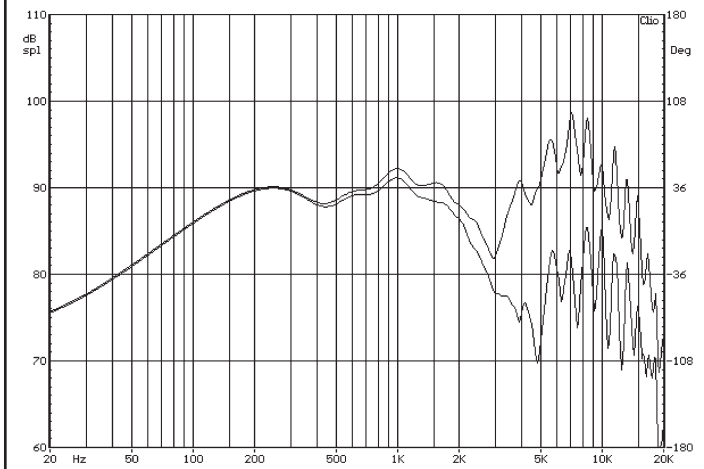

Note: Due to testing limitations, response below 200 Hz is not an actual representation.

Impedance/Phase

