

## RS150T-8

## 6" Reference Woofer Truncated Frame



## Features

- Lightweight black anodized aluminum cone
- Truncated cast frame
- Advanced low-distortion motor design
- Solid aluminum phase plug
- Rubber surround
- Perfect for line arrays

## Parameters

Impedance ( $\Omega$ )	8
Re ( $\Omega$ )	5.6
Le (mH) @ 1 kHz	0.74
Fs (Hz)	61.2
Qms	2.87
Qes	0.62
Qts	0.51
Mms (g)	6.77
Cms (mm/N)	1.00
Sd (cm <sup>2</sup> )	84.9
Vd (liters)	34.0
BL (Tm)	4.87
VAS (liters)	9.7
XMAX (mm)	4
VC Diameter (mm)	25
SPL (dB@1W/1m)	87.6
RMS Power Handling (w)	40
Usable Frequency Range (Hz)	45 - 3500

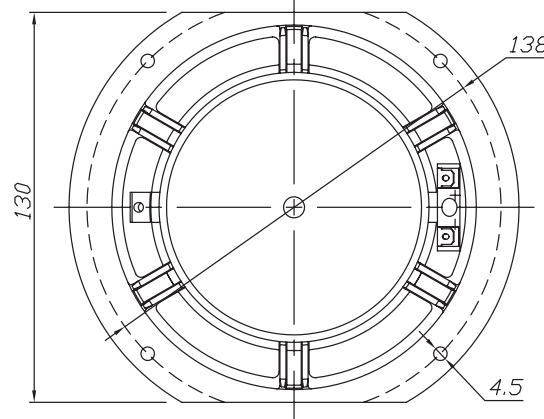
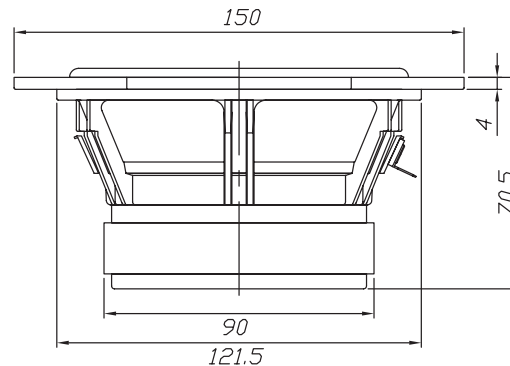

Note: All dimensions in mm.

## Frequency Response

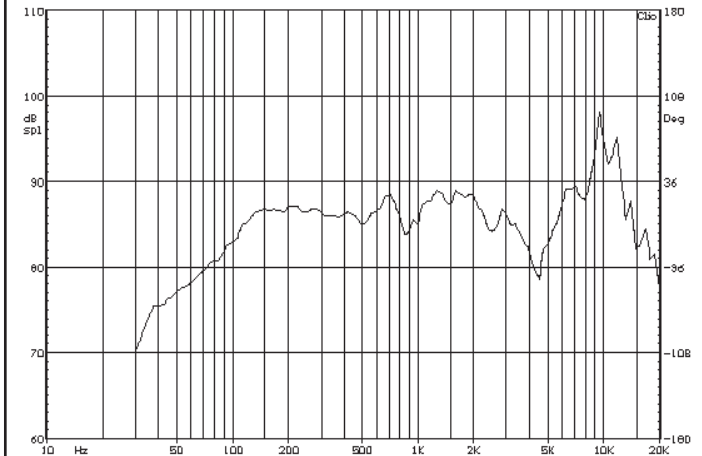

Note: Due to testing limitations, response below 200 Hz is not an actual representation.

## Impedance/Phase

