

**Features**

- 15" paper cone
- Treated cloth accordion surround and flat spider suspension
- Cast aluminum frame
- Large 4" Kapton voice coil
- Long excursion design
- Gold plated terminals
- Optimized for vented and horn loaded enclosures
- Made in the USA

**Parameters**

Impedance ( $\Omega$ )	8
Re ( $\Omega$ )	6.2
Le (mH) @ 1 kHz	2.49
Fs (Hz)	37.7
Qms	6.22
Qes	0.36
Qts	0.34
Mms (g)	101.5
Cms (mm/N)	0.18
Sd (cm <sup>2</sup> )	855.3
Vd (liters)	513.2
BL (Tm)	19.77
VAS (liters)	180.5
XMAX (mm)	6
VC Diameter (mm)	102
SPL (dB@1W/1m)	97.0
RMS Power Handling (w)	500
Usable Frequency Range (Hz)	35 - 2000

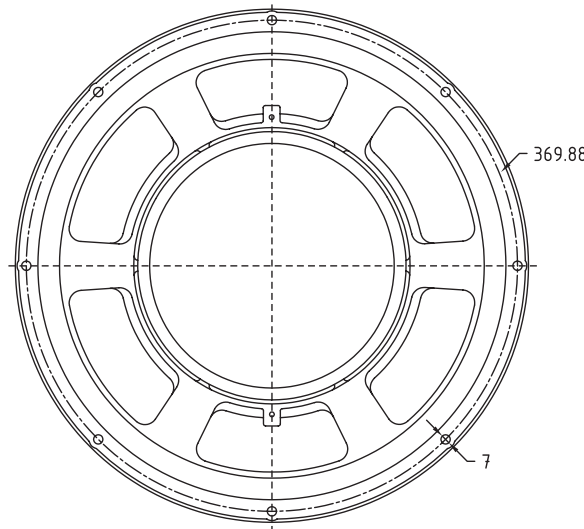
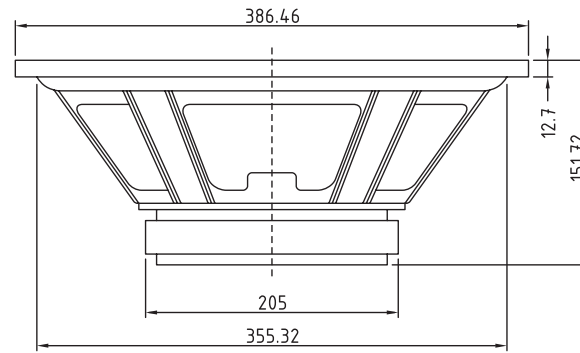

Note: All dimensions in mm.

**Frequency Response**

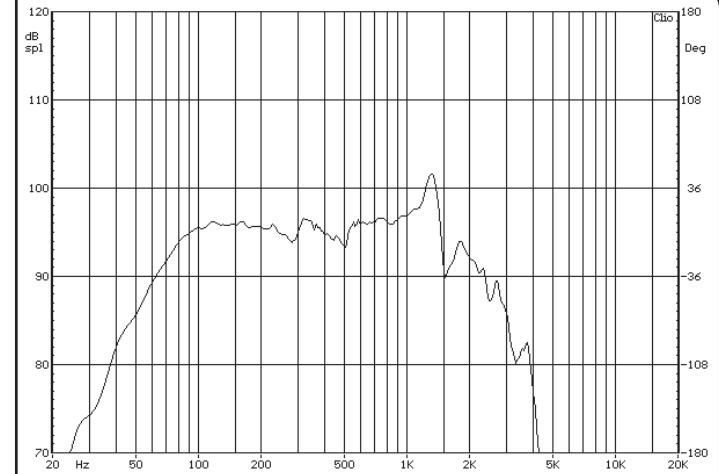

Note: Due to testing limitations, response below 200 Hz is not an actual representation.

**Impedance/Phase**

