

Features

- 1-1/8" textile soft dome
- Compact faceplate
- Powerful neodymium motor
- Ferrofluid cooled voice coil
- Clear and extended highs
- Great for line arrays

Parameters

Impedance (Ω)	6
Re (Ω)	5.4
Le (mH) @ 10 kHz	0.08
Fs (Hz)	1097.0
Qms	2.16
Qes	2.94
Qts	1.24
Mms (g)	
Cms (mm/N)	
Sd (cm ²)	4.9
Vd (liters)	
BL (Tm)	
VAS (liters)	
XMAX (mm)	
VC Diameter (mm)	25
SPL (dB@1W/1m)	91.0
RMS Power Handling (w)	30
Usable Frequency Range (Hz)	2200 - 20000

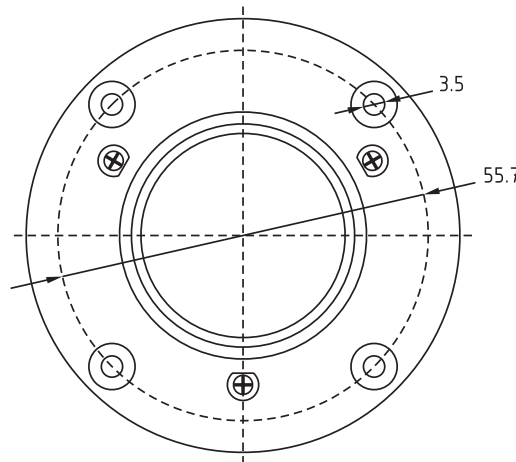
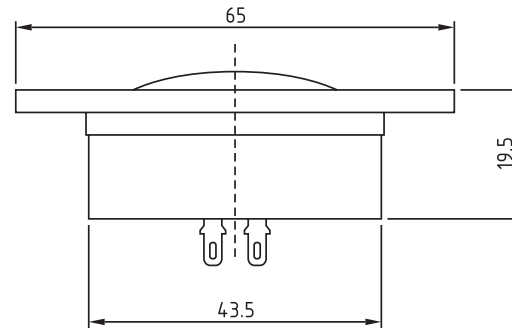

Note: All dimensions in mm.

Frequency Response

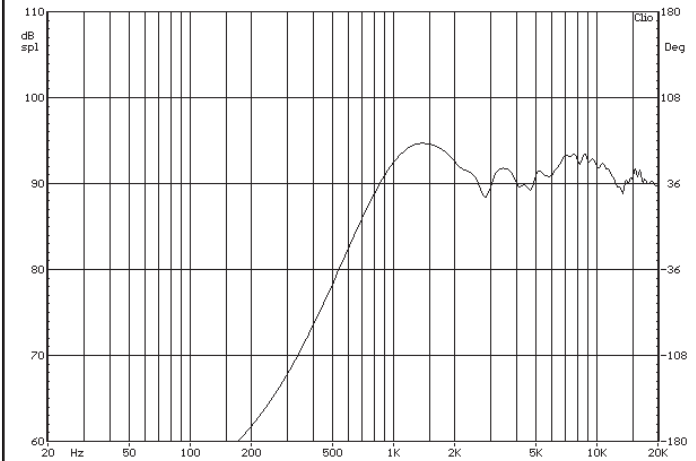

Note: Due to testing limitations, response below 200 Hz is not an actual representation.

Impedance/Phase

