

Features

- 15" Kevlar impregnated paper cone
- Large mechanical excursion
- Adjustable tuning
- Made in the USA

Parameters

Impedance (Ω)	
Re (Ω)	
Le (mH) @ 1 kHz	
Fs (Hz)	18.5
Qms	5.40
Qes	
Qts	
Mms (g)	225
Cms (mm/N)	0.33
Sd (cm ²)	805.0
Vd (liters)	1771.0
BL (Tm)	
VAS (liters)	300.5
XMAX (mm)	22
VC Diameter (mm)	
SPL (dB@1W/1m)	
RMS Power Handling (w)	
Usable Frequency Range (Hz)	

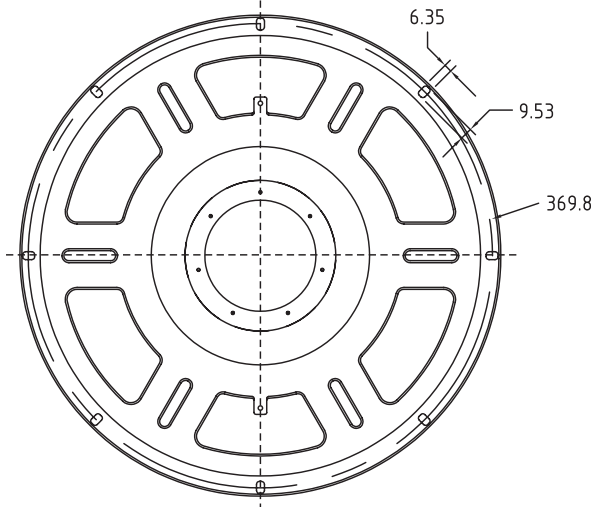
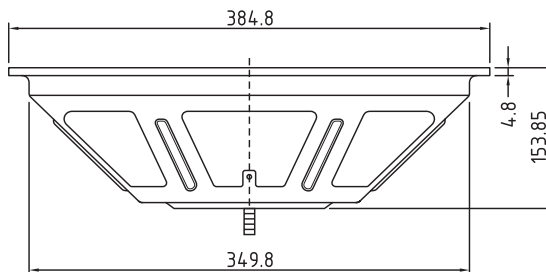

Note: All dimensions in mm.

Frequency Response

N/A

Note: Due to testing limitations, response below 200 Hz is not an actual representation.

Impedance/Phase

N/A