

Features

- 1-1/8" treated silk dome
- Damped rear chamber
- Ferrofluid cooled voice coil
- Low free air resonance
- European design and performance
- Very smooth on and off axis response

Parameters

Impedance (Ω)	8
Re (Ω)	5.5
Le (mH) @ 10 kHz	0.09
Fs (Hz)	637.2
Qms	0.82
Qes	0.90
Qts	0.43
Mms (g)	
Cms (mm/N)	
Sd (cm ²)	6.6
Vd (liters)	
BL (Tm)	
VAS (liters)	
XMAX (mm)	
VC Diameter (mm)	29
SPL (dB@1W/1m)	89.0
RMS Power Handling (w)	50
Usable Frequency Range (Hz)	2000 - 20000

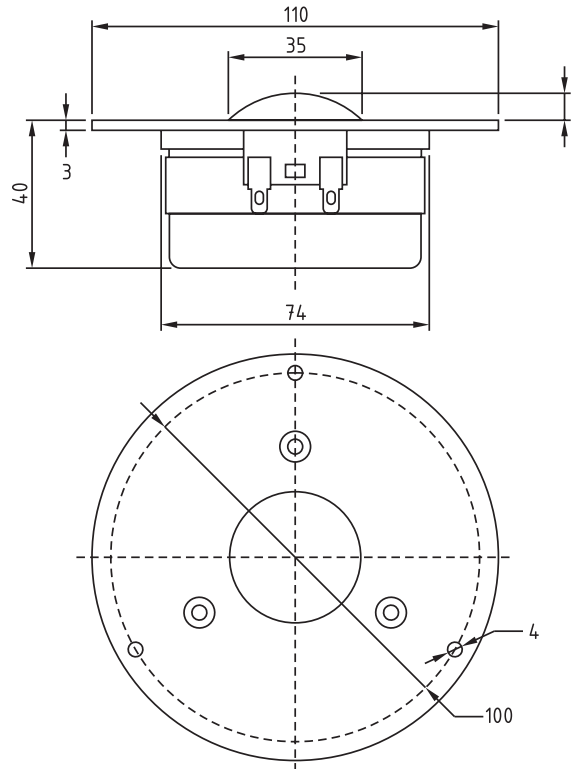

Note: All dimensions in mm.

Frequency Response

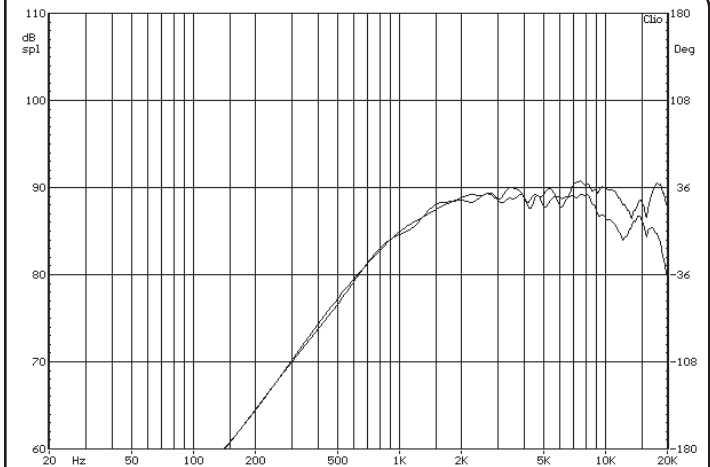

Note: Due to testing limitations, response below 200 Hz is not an actual representation.

Impedance/Phase

